

3 ARRAY
scale 1:7

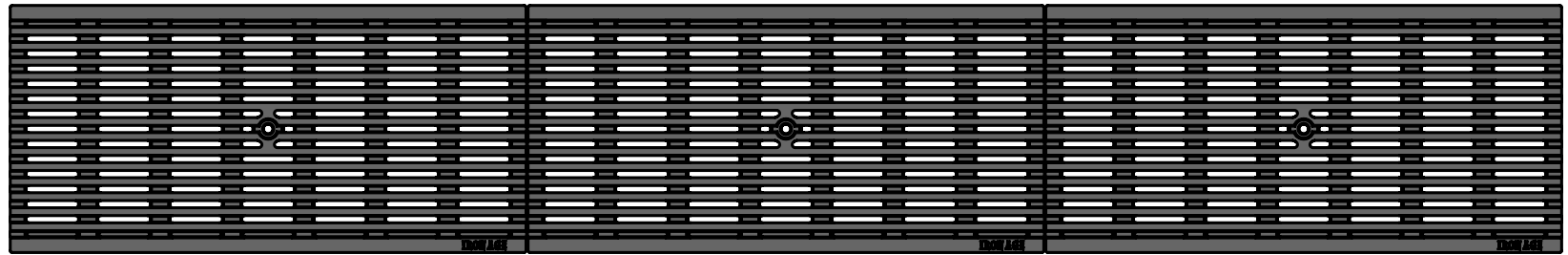

TOP VIEW
scale 1:4

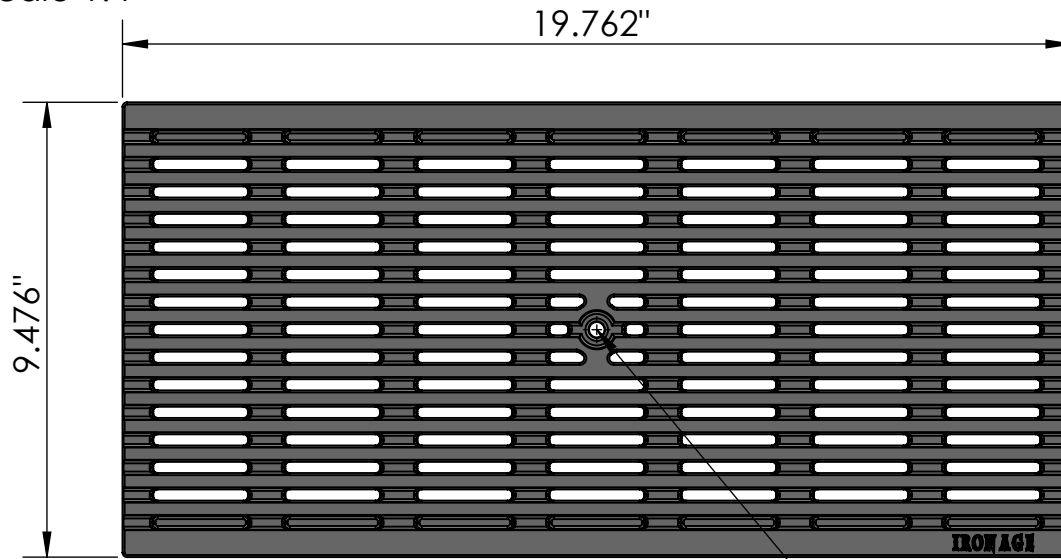

END VIEW
scale 1:4

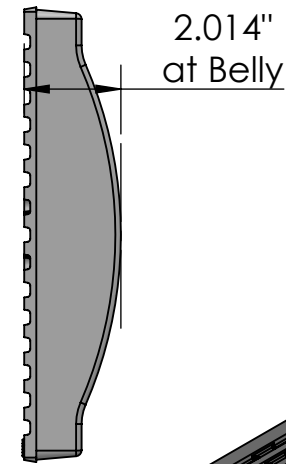

CASTING-ID
scale 1:3

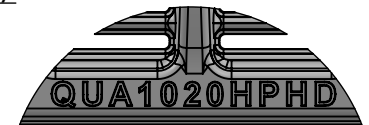

SIDE VIEW
scale 1:4

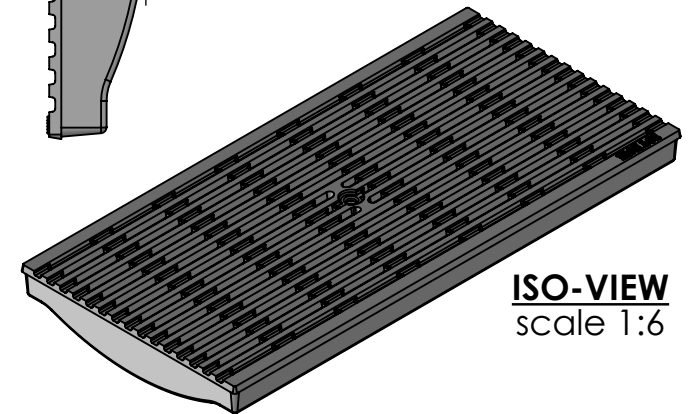
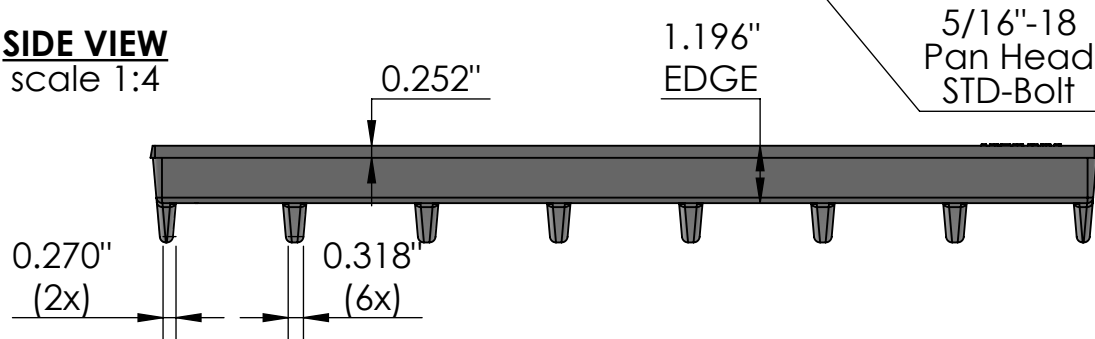

ISO-VIEW
scale 1:6

NOTES:

1. Heelproof: No thru openings greater than 1/4".
2. Ships in pieces: 1
3. Due to casting inconsistencies, all dimensions are nominal.

Made in USA ©2018 Iron Age Designs

Que 10" x 20" Trench Grate - Heel Proof, Heavy Duty

 IRON AGE DESIGNS Telephone 206.276.0925 www.ironagegrates.com	Material: Ductile Iron 65-45-12	Weight: 29.27 lbs.	Free Drain Area: 40.28 in/sq., or 21.51 %	By: MS Checked: MS Date: 4-26-22
	Finish: Raw	Edge: 1.1875"	Flow Rate: 52.76 GPM, or .117 CuFt./sec.	© Registration: Pending Scale: NTS
	Fits: ACO-K200	Product ID: QUA10-20I24HPPHD	Drawing Name: 02_QUE_A_10x20HPPHD_TrenchGrate_Iron	